

SISTEMI PER
CANCELLI A BATTENTE.

G:B:D
CREATIVE AUTOMATIONS

BL233

230V



FOTO AUTOMATIC GATES ▶



Operatore elettromeccanico a 230 Vac con finecorsa, dedicato ai cancelli a battente di medie e grandi dimensioni e peso. Adatto per un uso intensivo.

FACILE DA INSTALLARE

Motore e finecorsa già cablati, staffe di fissaggio rinforzate in dotazione.

SILENZIOSO E VELOCE

Realizzato con ingranaggi in acciaio, bronzo-alluminio, tiranti in acciaio inox e motore con avvolgimento speciale per una maggiore silenziosità ed uso gravoso.

TECNOLOGICO E SICURO

Lo speciale avvolgimento dello statore consente di ottenere un servizio gravoso come nessun altro prodotto sul mercato a 230vac. Dotato di un dispositivo di sblocco con chiave personalizzata a profilo europeo per aprire manualmente in caso di black-out.

QUALITÀ E AFFIDABILITÀ

Una scelta di materiali senza compromessi. Corpo in alluminio pressofuso ad alta densità, 4 tiranti in acciaio inox rinforzati, ingranaggi in acciaio e bronzo-alluminio, fermi meccanici di sicurezza integrati. Potente, silenzioso e pronto a lavorare per molti anni.

CARATTERISTICHE TECNICHE

	BL233
Utilizzo	INTENSIVO
Frequenza di utilizzo	40%
Alimentazione motore	230 Vac - 50/60 Hz
Potenza assorbita	200W
Grado di protezione	IP53
Velocità dello stelo	16 mm/s
Corsa max. stelo	500 mm
Forza max. spinta	3000 N
Regolazione della forza	ELETTRONICA
Regolazione della velocità	SI **
Lunghezza max. anta	5 m *
Temp. di funzionamento	-20°C +60°C
Encoder/Finecorsa	FINECORSO - Apertura e chiusura
Lubrificazione	GRASSO GBD WH-01
Peso operatore	11,3 Kg

* in caso di applicazione su ante cieche/tamburate o superiori a 2,5 m, si consiglia l'uso di una elettroserratura

** tramite apposita apparecchiatura di comando: BA230

DIAGRAMMA DI APPLICAZIONE

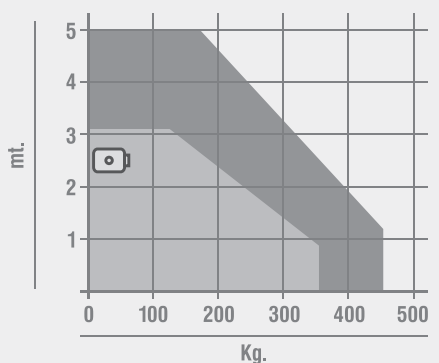

■ Applicazione consigliata ■ Applicazione limite
 □ Elettroserratura

QUOTE D'INSTALLAZIONE

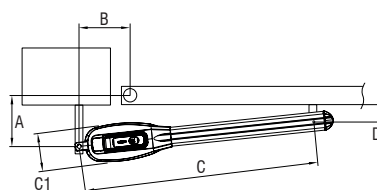

	B	A	B	C	D	C1
BL233	90°	220	200	860	150	139x197
BL233	90°	240	240	872	150	139x197
BL233	110°	180	200	870	120	139x197

DIMENSIONI

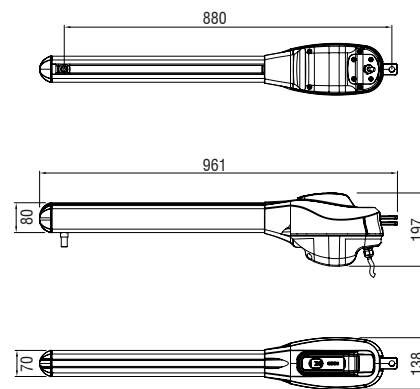

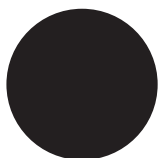

SWING GATE SYSTEMS.

G·B·D·
CREATIVE AUTOMATIONS

BL233

230V



FOTO AUTOMATIC GATES ▶



Electromechanical operator in 230 Vac with limit switches, for swinging gates of medium and big size and weight, for heavy use.

EASY TO INSTALL

Motor and limit switches already cabled, reinforced fixing brackets included.

SILENT AND FAST

Made with gears in steel and bronze-aluminium, tension rods in stainless steel and motor with special winding for more silence and heavy use.

TECHNOLOGICAL AND SAFE

The special winding of the stator allows to obtain a heavy service as any other product in 230Vac in the market. It is provided with an unlocking device with personalized key with European profile to manually open in case of black-out.

QUALITY AND RELIABILITY

A choice of materials without compromises. Body in die-cast aluminium at high density, 4 reinforced tension rods in stainless steel, gears in steel and bronze-aluminium, safety mechanical stops built-in. Powerful, silent and ready to work for many years.

TECHNICAL FEATURES

	BL233
Type of use	INTENSIVE
Frequency of use	40%
Motor power supply	230 Vac - 50/60 Hz
Absorbed power	200W
Protection degree	IP53
Rod speed	16 mm/s
Max rod stroke	500 mm
Max thrust force	3000 N
Adjustable force	ELECTRONIC
Adjustable speed	YES **
Max leaf width	5 m *
Operating temperature	-20°C +60°C
Encoder/Limit switch	LIMIT SWITCHES O/C
Type of lubrication	GREASE GBD WH-01
Weight of the unit	11,3 Kg

* in case of blind leaf or wind presence or leaf over 2.5m, the use of the electric lock is highly suggested

** by the use of the BA230 control board

APPLICATION DIAGRAM

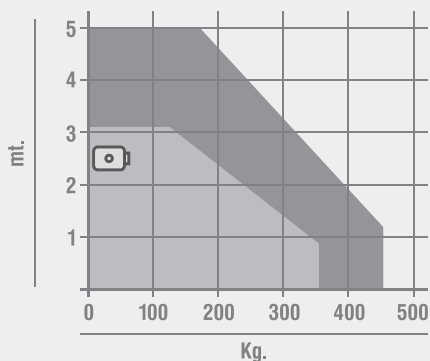

■ Suggested application ■ Max application
 ☑ Electric-lock

INSTALLATION MEASURES

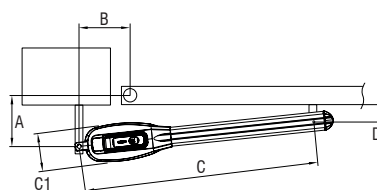

	B	A	B	C	D	C1
BL233	90°	220	200	860	150	139x197
BL233	90°	240	240	872	150	139x197
BL233	110°	180	200	870	120	139x197

DIMENSIONS

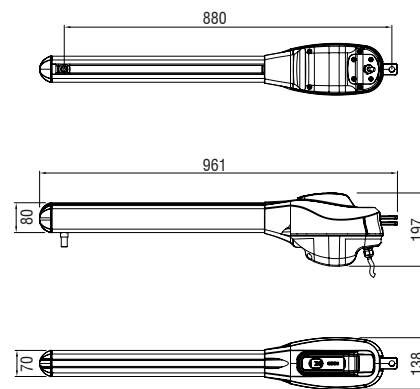

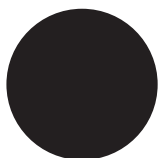

SISTEMAS PARA
CANCELAS BATIENTES.

G:B:D:
CREATIVE AUTOMATIONS

BL233

230V



FOTO AUTOMATIC GATES ▶



Operador electromecánico de 230 Vac con finales de carrera, para cancelas batientes de medias y grandes dimensiones y peso, para uso intensivo.

FÁCIL INSTALACIÓN

Motor y final de carrera ya alambrado, abrazaderas de fijación reforzadas incluidas.

SILENCIOSO Y RÁPIDO

Realizado con engranajes en acero y bronce-aluminio, tirantes en acero inox y motor con bobinado especial para ausencia de ruido y un uso gravoso.

TECNOLÓGICO Y SEGURO

El especial bobinado del estátor permite obtener un servicio gravoso como ningún otro producto en el mercado de los 230vac. Previsto de un dispositivo de desbloqueo con llave personalizada a perfil Europeo, para abrir manualmente en caso de black-out.

CALIDAD Y FIABILIDAD

Una selección de materiales sin compromisos. Cuerpo en aluminio fundido a presión a alta densidad, 4 tirantes en acero inox reforzado, engranajes en acero y bronce-aluminio, retenes mecánicos de seguridad integrados. Potente, silencioso y listo para trabajar por muchos años.

CARACTERÍSTICAS TÉCNICAS

	BL233
Uso	INTENSIVO
Frecuencia de uso	40%
Alimentación del motor	230 Vac - 50/60 Hz
Potencia absorbida	200W
Grado de protección	IP53
Velocidad del vástago	16 mm/s
Carrera máx vástago	500 mm
Fuerza máx de empuje	3000 N
Regulación fuerza	ELECTRÓNICA
Regulación velocidad	SÍ **
Longitud máx puerta	5 m *
Temp. de funcionamiento	-20°C +60°C
Encoder/Final de carrera	FINAL DE CARRERA A/C
Tipo de lubricación	GRASA GBD WH-01
Peso del operador	11,3 Kg

* En caso de aplicación en puertas ciegas o superiores a 2,5 m, se recomienda utilizar una electrocerradura

** Para central BE24

DIAGRAMA DE APLICACIÓN

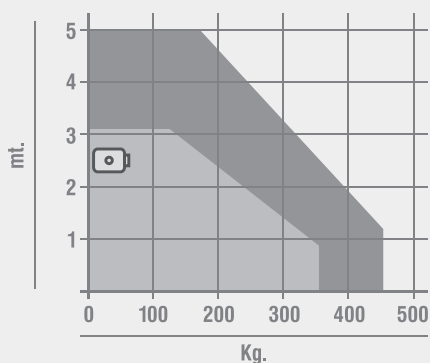

■ Aplicación sugerida ■ Aplicación máx.
 ☐ Electrocerradura

COTAS DE INSTALACIÓN

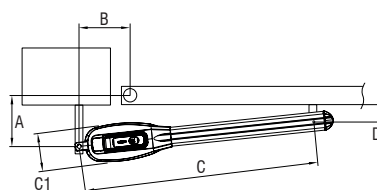

	B	A	B	C	D	C1
BL233	90°	220	200	860	150	139x197
BL233	90°	240	240	872	150	139x197
BL233	110°	180	200	870	120	139x197

DIMENSIONES

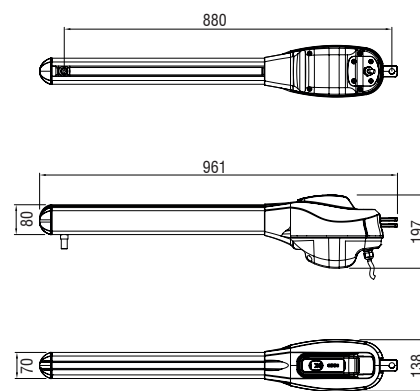

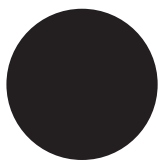

SYSTÈMES POUR
PORTAILS BATTANTS.

G:B:D
CREATIVE AUTOMATIONS

BL233

230V



FOTO AUTOMATIC GATES ▶



Opérateur électromécanique à 230 Vac avec fins de course, pour portails battants de moyens et grands dimensions et poids, pour une utilisation intensive.

FACIL A INSTALLER

Moteur et fins de course déjà câblés, brides de fixation renforcées en dotation.

SILENCIEUX ET RAPIDE

Réalisé avec engrenages en acier et bronze-aluminium, tirants en acier inox et moteur avec bobinage spécial pour une plus grand silence et une utilisation intensive.

TECHNOLOGIQUE ET SUR

Le spécial bobinage du stator permet d'obtenir un service lourd comme aucun autre produit à 230Vac dans le marché. Pourvu d'un dispositif de déverrouillage avec clé personnalisée à profil Européen pour ouvrir manuellement en cas de black-out.

QUALITE ET FIABILITE

Une choix de matériels sans compromis. Corps en aluminium moulé à haute densité, 4 tirants en acier inox renforcés, engrenages en acier et bronze-aluminium, arrêts mécaniques de sécurité intégrés. Puissant, silencieux et prêt pour travailler pendant de nombreuses années.

CARACTÉRISTIQUES TECHNIQUES

	BL233
Utilisation	INTENSIF
Fréquence d'utilisation	40%
Alimentation moteur	230 Vac - 50/60 Hz
Puissance absorbée	200W
Degré de protection	IP53
Vitesse de la tige	16 mm/s
Course maxi tige	500 mm
Force maxi poussé	3000 N
Réglage de la force	ÉLECTRONIQUE
Réglage de la vitesse	OUI **
Longueur maxi porte	5 m *
Température fonctionnement	-20°C +60°C
Encodeur / Fin de course	FIN DE COURSE 0/F
Type de lubrification	GRAISSE GBD WH-01
Poids de l'opérateur	11,3 Kg

* En cas d'application sur portes plaines ou supérieures à 2,5m de largeur, il est conseillé d'installer une électroserrure
 ** par centrale BE24

DIAGRAMME D'APPLICATION

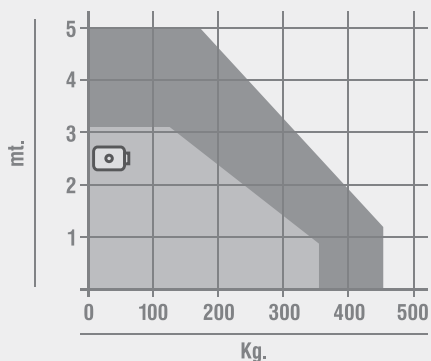

■ Application conseillée ■ Application maxi.
 ☑ Électro-serrure

CÔTES D'INSTALLATION

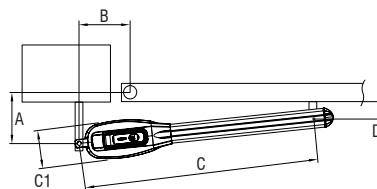

	B	A	B	C	D	C1
BL233	90°	220	200	860	150	139x197
BL233	90°	240	240	872	150	139x197
BL233	110°	180	200	870	120	139x197

DIMENSIONS

